



**STRONGER  
THAN STEEL.™**



REACH THE FINISH LINE  
A WHOLE LOT FASTER.



You've got a lot of space to cover, and it's not all on the jobsite. ClarkDietrich finishing products elevate the quality of your craft and help eliminate the stuff that slows you down. From interior to exterior, our systems save steps, materials and hassles, so you can trade in the walls for whatever's waiting for you outside.

**LEARN MORE AT**  
clarkdietrich.com

OVERTIME		REGULAR TIME	
	AM	IN	OUT
DAY 1		IN	OUT
	PM	IN	OUT
DAY 2		IN	OUT



**flexible corner beads - paper-faced composite**

Strait-Flex Gold	4
Strait-Flex Mid-Flex	5
Strait-Flex Wide-Flex	5

**flexible corner beads - composite**

Strait-Flex Medium	6	Strait-Flex Uno-Bead <sup>222</sup>	9
Strait-Flex Original	7	Strait-Flex Wet-Flex	9
Strait-Flex Arch-Flex	7		

**stick corner beads - paper-faced composite**

Strait-Flex IS-300	10	Strait-Flex OS-400	11
Strait-Flex OS-300	11		

**stick corner beads - composite**

Strait-Flex Arch-Stick	12	Strait-Flex Wet-Stick	13
Strait-Flex Big-Stick	13		

**premium trims & tapes**

Strait-Flex Perfect-90°	14	Strait-Flex L-Bead	15	Strait-Flex Tile-Tape	17
Strait-Flex Ammo-Flex	14	Strait-Flex Tuff-Tape	16	Strait-Flex Butt-Tape	17
Strait-Flex Edge-Tape	15	Strait-Flex Crack-Tape	16		

**patches**

Ultra-Patch	18	Head-Patch	20	Can-Patch <sup>COMMERCIAL</sup>	21
Roll-Patches	18	Black-Iron Patch	20	Deck-Patch	21
Perma-Patch	19	Pipe-Patch	20		
Outlet-Patch	19	Can-Patch <sup>RESIDENTIAL</sup>	21		

**tools & accessories**

Mud-Pro <sup>2</sup>	22	Super-Bond	24	Extension Pole	25
Inside Rolling Tools	23	Drywall Shims	24	Flex-Folder	25
Outside Rolling Tools	23	Multi-Purpose Sprayer	24	Scissors	25

**x-crack**

Strait-Flex X-Crack	26
---------------------	----

# Flexible Corner Beads

## PAPER-FACED COMPOSITE

### FEATURES

- High-performance drywall corner bead.
- Memory-free hinge produces straight corners and perfect angles.
- Installs with all-purpose joint compound.
- Composite structural backing provides strength and a superior bond to the drywall surface.
- Diamond-punched paper edging provides maximum adhesion - no cracks, no call backs.
- Finishing compound is not required over the laminated area - uses half the compound vs. standard corner bead.
- Paper will not fuzz-up during sanding.
- Resists dents and common cracking problems.



## Strait-Flex Gold

FINISHES INSIDE & OUTSIDE 90° AND OFF-ANGLE CORNERS

2 1/2" w (63mm)

- Inside and outside corners where common gaps in drywall are present.
- Great for vaulted, coffered and tray ceilings, bay windows.
- Inside 90° corners where a large fill or straightening is required, no back filling needed.



SPECIFICATIONS	
100 FT ROLLS	WHOLESALE CASE
Item Size: 2 1/2" x 100' (63mm x 30.5m)	Case Item No. <b>GOLD-100</b>
Item Weight: 3.1 lbs. (1.4kg)	Case Pack: 10 rolls
Item UPC: 7-51361-50316-6	Case UPC: 7-51361-50317-3
	Case Weight: 32 lbs. (14.5kg)
	Cases per Pallet: 24
	Pallet Weight: 832 lbs. (377kg)
	Pallet Size: 40" x 48" x 66"

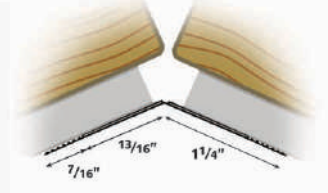
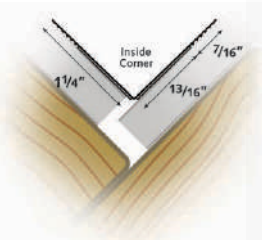
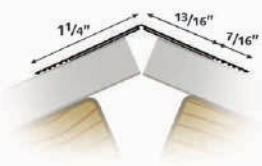
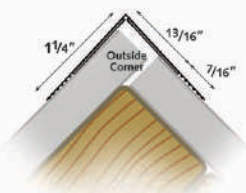

## Strait-Flex Mid-Flex

FINISHES INSIDE AND OUTSIDE 90° AND OFF-ANGLE CORNERS

3" w (76mm)



- Outside corners where common gaps in drywall are present.
- Outside corners where a large fill or straightening is required, no back filling needed.
- Great for vaulted, coffered and tray ceilings, bay windows.

### SPECIFICATIONS

#### 100 FT ROLLS

Item Size: 3" x 100'  
(76mm x 30.5m)  
Item Weight: 4 lbs. (1.81kg)  
Item UPC: 7-51361-50318-0

#### WHOLESALE CASE

Case Item No. **MF-100**  
Case Pack: 10 rolls  
Case UPC: 7-51361-50319-7  
Case Weight: 39 lbs. (17.7kg)  
Cases per Pallet: 24  
Pallet Weight: 976 lbs. (443kg)  
Pallet Size: 40" x 48" x 60"

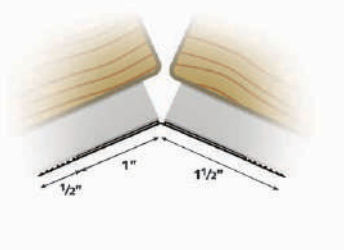
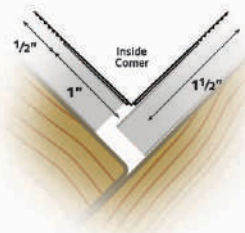
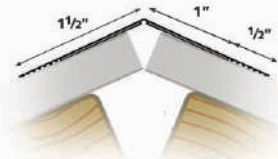
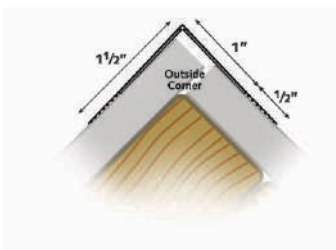

## Strait-Flex Wide-Flex

FINISHES INSIDE AND OUTSIDE 90° AND OFF-ANGLE CORNERS

4" w (102mm)



- Outside corners where large gaps in drywall are present.
- Hard-to-straighten corners outside and vaulted ceilings.
- Outside corners for double 5/8" drywall.
- Great for vaulted, coffered, tray and cathedral ceilings.

### SPECIFICATIONS

#### 100 FT ROLLS

Item Size: 4" x 100'  
(102mm x 30.5m)  
Item Weight: 4 lbs. (1.81kg)  
Item UPC: 7-51361-50320-3

#### WHOLESALE CASE

Case Item No. **WF-100**  
Case Pack: 7 rolls  
Case UPC: 7-51361-50321-0  
Case Weight: 41 lbs. (18.6kg)  
Cases per Pallet: 24  
Pallet Weight: 1,024lbs. (465kg)  
Pallet Size: 40" x 48" x 71"

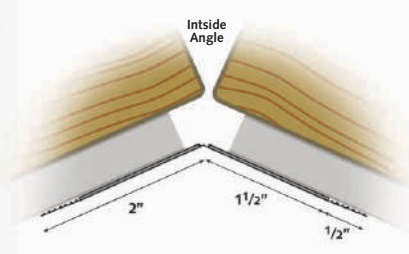
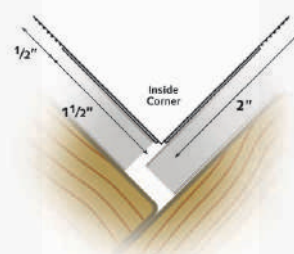
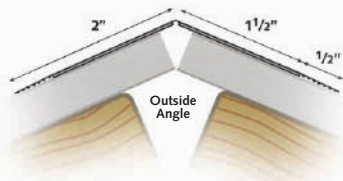
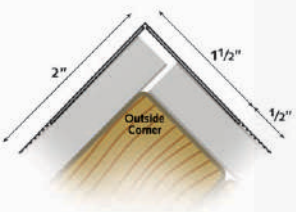

# Flexible Corner Beads

## COMPOSITE

### FEATURES

High-performance drywall corner bead.

Installs with all-purpose compound.

Spans gaps in drywall. No back-filling required.

Composite fiber backing embeds into compound to provide a superior bond to the drywall surface.

First finishing coat of compound can be applied immediately with no delayed shrinkage, no edge cracking.

Full composite construction, no paper.

Resists dents and common cracking problems.



## Strait-Flex Medium

FINISHES INSIDE 90° & OFF-ANGLE CORNERS

2 1/4" w (57mm)

- Twice as fast and twice as strong as conventional paper or mesh tapes.
- Inside corners where small gaps in drywall are present.
- Inside 90° corners where a small fill or minor straightening is required, no back filling needed.
- Great for vertical and wall-to-ceiling inside corners, inside angles of bay windows.



### SPECIFICATIONS

#### 100 FT ROLLS

Item Size: 2 1/4" 100'  
(57mm x 30.5m)  
Item Weight: 2.5 lb. (1.13kg)  
Item UPC: 7-51361-50336-4

#### WHOLESALE CASE

Case Item No. **SM-100**  
Case Pack: 12 rolls  
Case UPC: 7-51361-50337-1  
Case Weight: 30 lbs. (13.6kg)  
Cases per Pallet: 24  
Pallet Weight: 750 lbs. (327kg)  
Pallet Size: 31" x 31" x 50"

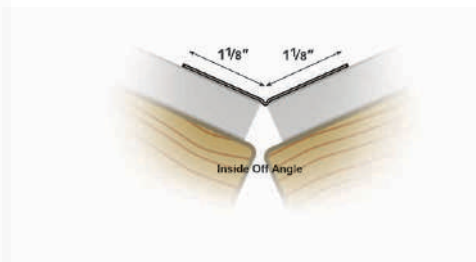
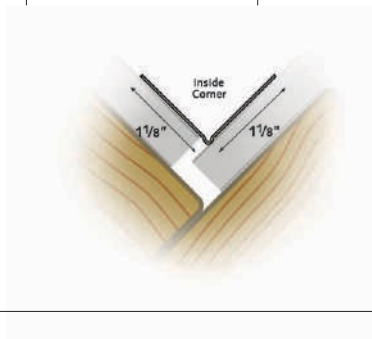



## Strait-Flex Original

FINISHES INSIDE AND OUTSIDE 90° AND OFF-ANGLE CORNERS

2 3/8" w (60mm)



- Replaces standard corner bead and uses half the compound.
- Spans common gaps in drywall. No back-filling required.
- Great for coffered and tray ceilings, bay windows.
- Inside corners where gaps in drywall are present.

### SPECIFICATIONS

#### 100 FT ROLLS

Item Size: 2 3/8" x 100'  
(60mm x 30.5m)  
Item Weight: 2.8 lb. (1.3kg)  
Item UPC: 7-51361-50338-8

#### WHOLESALE CASE

Case Item No. **SO-100**  
Case Pack: 12 rolls  
Case UPC: 7-51361-50339-5  
Case Weight: 34 lbs. (15.4kg)  
Cases per Pallet: 24  
Pallet Weight: 846 lbs. (384kg)  
Pallet Size: 32" x 32" x 53"

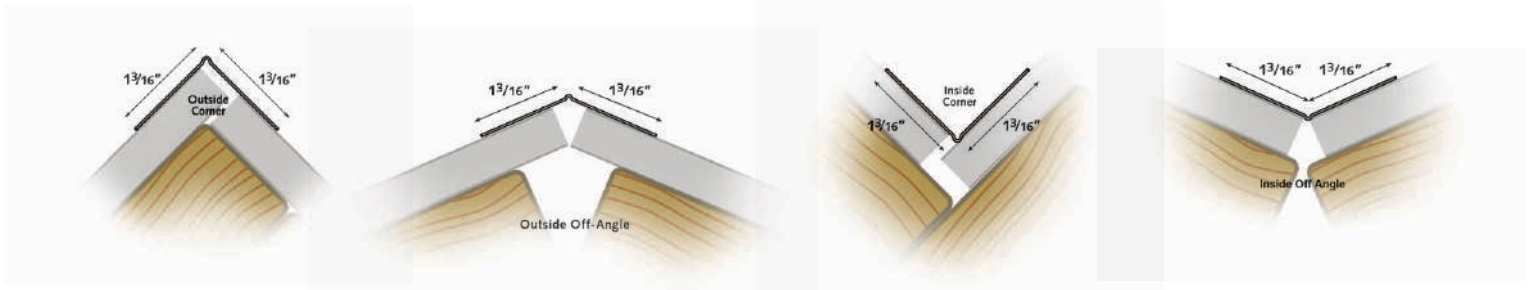

## Strait-Flex Arch-Flex

DESIGNED FOR COMPOUND ARCHES AND DOUBLE CURVE APPLICATIONS

3 3/8" w (86mm)



- Arched windows and doors, tight radius curves, and free-form curves.
- Curved walls, ceilings, soffits, staircases, barrel vaults, and cathedral ceilings.
- Installs using standard compounds. No special tools or fasteners needed.
- Taping around circular air ducts.
- Produces smooth, professional-looking curves. Tear strips allow for easy straight-to-curve transitions.
- Resists dents, paint chipping, shrinkage, and common cracking problems.

### SPECIFICATIONS

#### 50 FT ROLLS

Item Size: 3 3/8" x 50'  
(86mm x 15.25m)  
Item Weight: 2.5 lbs. (1.13kg)  
Item UPC: 7-51361-50340-1

#### WHOLESALE CASE

Case Item No. **AF-50**  
Case Pack: 12 rolls  
Case UPC: 7-51361-50341-8  
Case Weight: 30 lbs. (13.6kg)  
Cases per Pallet: 16  
Pallet Weight: 510 lbs. (231kg)  
Pallet Size: 30" x 30" x 49"

#### 100 FT ROLLS

Item Size: 3 3/8" x 100'  
(86mm x 30.5m)  
Item Weight: 4.8 lbs. (2.18kg)  
Item UPC: 7-51361-50342-5

#### WHOLESALE CASE

Case Item No. **AF-100**  
Case Pack: 12 rolls  
Case UPC: 7-51361-50343-2  
Case Weight: 58 lbs. (26.3kg)  
Cases per Pallet: 20  
Pallet Weight: 1126 lbs. (511kg)  
Pallet Size: 34" x 34" x 48"

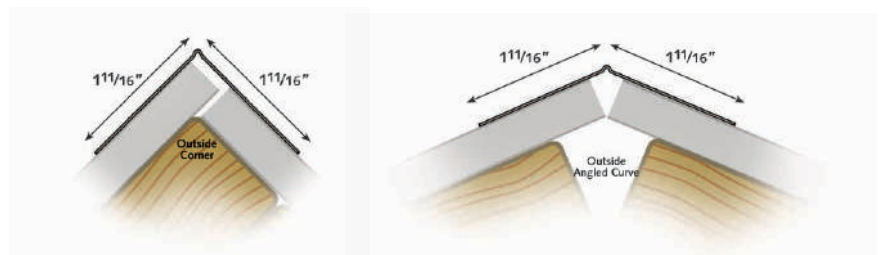

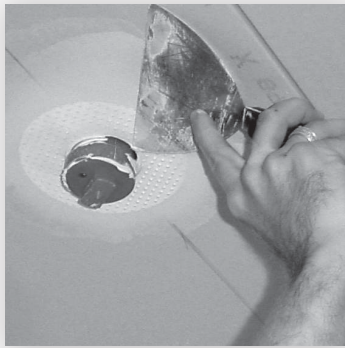
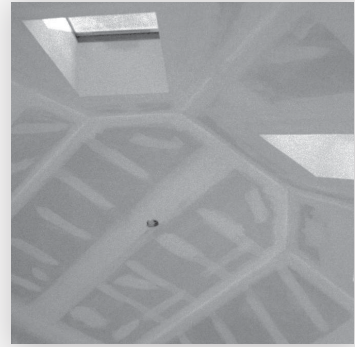
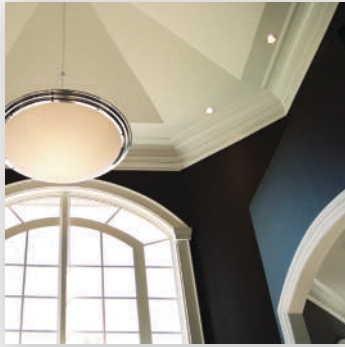
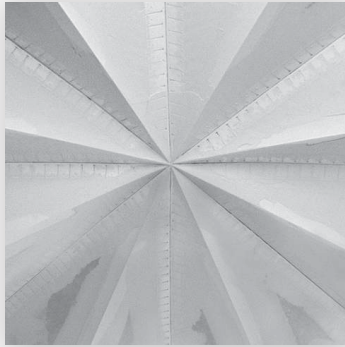



## Strait-Flex Uno-Bead 222

DESIGNED FOR REPLACING OR REPAIRING METAL CORNER BEAD

2.22" w (56mm)



- Creates perfect inside and outside corners.
- Ideal for drywall, thin-coat plaster applications.
- High traffic areas where bumps and dents commonly occur.
- Permanent replacement for damaged metal corner bead.
- Eliminates edge cracking.

### SPECIFICATIONS

#### 100 FT ROLLS

Item Size: 2<sup>1</sup>/<sub>4</sub>" x 100'  
(57mm x 30.5m)  
Item Weight: 2.5 lbs. (1.1kg)  
Item UPC: 7-51361-50348-7

#### WHOLESALE CASE

Case Item No. **UB222-100**  
Case Pack: 12 rolls  
Case UPC: 7-51361-50349-4  
Case Weight: 30 lbs. (13.6kg)  
Cases per Pallet: 24

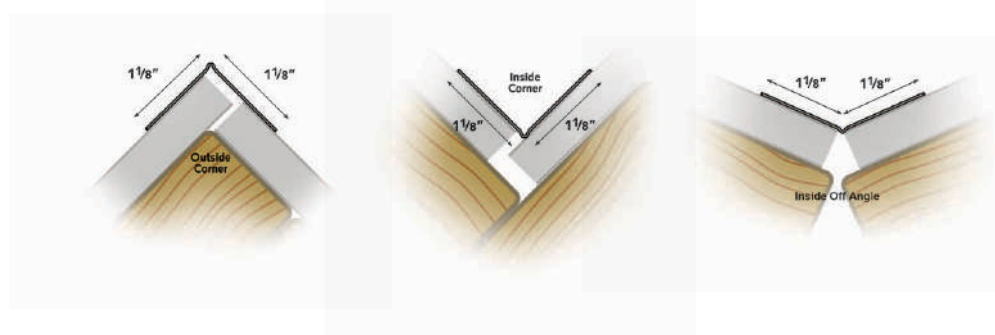

## Strait-Flex Wet-Flex

DESIGNED AS A WATER-ACTIVATED OUTSIDE 90° AND OUTSIDE OFF-ANGLE CORNER BEAD ON A ROLL

3" w (76mm)



- Easily transported to and from job site. No waste.
- Water-activated adhesive on inside of roll.
- Impact-resistant nose.
- Small bead creates a perfect, clean edge.
- Small fill coat. Fast drying.
- No paper-face to fuzz-up, burn-through, delaminate, or curl.
- No delayed shrinkage.
- No edge cracking.

### SPECIFICATIONS

#### 100 FT ROLLS

Item Size: 3" x 100'  
(76mm x 30.5m)  
Item Weight: 4.9 lbs. (2.2kg)  
Item UPC: 7-51361-50350-0

#### WHOLESALE CASE

Case Item No. **WETF-100**  
Case Pack: 8 rolls  
Case UPC: 7-51361-50351-7  
Case Weight: 40 lbs. (18.1kg)  
Cases per Pallet: 24

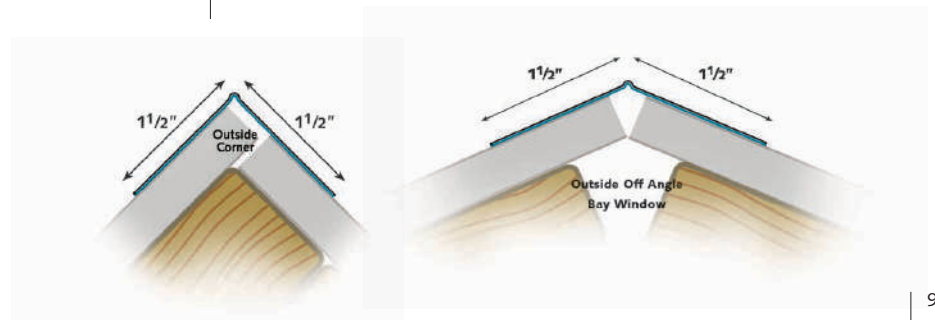

# Stick Corner Beads

## PAPER-FACED COMPOSITE

### FEATURES

Clean, square, low-profile installation.

Composite backing provides a tough, durable corner.

Diamond-punched paper edging allows for easier feathering, faster drying, and the highest bonding strength. Also guarantees an even lay down of paper, providing maximum adhesion with no rippling or blistering.

Paper surface is pre-treated to accept paint. Finishing compound is not required over laminated area.

Perfect corners without paper fuzz-up during finishing and sanding.

Straightens common framing irregularities.

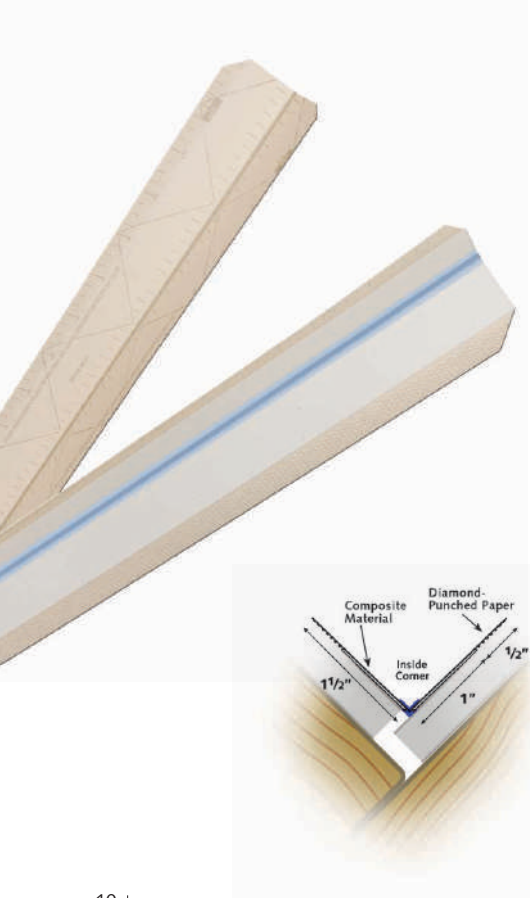

## Strait-Flex IS-300

DESIGNED FOR INSIDE 90° CORNERS WHERE SPEED, AND STRENGTH ARE NEEDED, AND WHERE LARGE FRAMING IRREGULARITIES NEED TO BE OVERCOME

3" w (76mm)

- Vertical or horizontal inside 90° corners.
- Diamond-punched paper edging allows for easier feathering, faster drying, and the highest bonding strength. Also guarantees an even lay-down of the paper, providing maximum adhesion with no rippling or blistering.
- Clean installation.
- Composite PVC provides a tough, durable corner.
- Perfect corners without paper fuzz-up during finishing and sanding.

### SPECIFICATIONS

8 FT STICK (244cm)	9 FT STICK (274cm)	10 FT STICK (305cm)	12 FT STICK (366cm)
Item No. <b>IS300-8</b> Item Size: 3" x 8' (76mm x 244cm)	Item No. <b>IS300-9</b> Item Size: 3" x 9' (76mm x 274cm)	Item No. <b>IS300-10</b> Item Size: 3" x 10' (76mm x 305cm)	Item No. <b>IS300-12</b> Item Size: 3" x 12' (76mm x 366cm)
WHOLESALE CASE	WHOLESALE CASE	WHOLESALE CASE	WHOLESALE CASE
Case Pack: 50pc. 400 lf (122m) Case UPC: 7-51361-50276-3 Case Weight: 18 lbs. (8.2kg) Cases per Pallet: 32	Case Pack: 50pc. 450 lf (137m) Case UPC: 7-51361-50278-7 Case Weight: 20.4 lbs. (9.3kg) Cases per Pallet: 32	Case Pack: 50pc. 500 lf (152m) Case UPC: 7-51361-50280-0 Case Weight: 23 lbs. (10.4kg) Cases per Pallet: 32	Case Pack: 50pc. 600 lf (183m) Case UPC: 7-51361-50282-4 Case Weight: 27.6 lbs. (12.5kg) Cases per Pallet: 32





## Strait-Flex OS-300

DESIGNED FOR SQUARE, LOW-FILL OUTSIDE 90° CORNERS

3" w (76mm)

- Vertical or horizontal outside 90° corners.
- Diamond-punched paper edging allows for easier feathering, faster drying, and the highest bonding strength. Also guarantees an even lay-down of the paper, providing maximum adhesion with no rippling or blistering.
- Clean installation.
- Composite backing provides a tough, durable corner with no rust.
- Nose resists dents and ensures perfect corners without paper fuzz-up during finishing and sanding.

### SPECIFICATIONS

8 FT STICK (244cm)	9 FT STICK (274cm)	10 FT STICK (305cm)	12 FT STICK (366cm)
Item No. <b>OS300-8</b> Item Size: 3" x 8' (76mm x 244cm)	Item No. <b>OS300-9</b> Item Size: 3" x 9' (76mm x 274cm)	Item No. <b>OS300-10</b> Item Size: 3" x 10' (76mm x 305cm)	Item No. <b>OS300-12</b> Item Size: 3" x 12' (76mm x 366cm)
WHOLESALE CASE	WHOLESALE CASE	WHOLESALE CASE	WHOLESALE CASE
Case Pack: 50pc. 400 lf (122m) Case UPC: 7-51361-50160-5 Case Weight: 18 lbs. (8.2kg) Cases per Pallet: 32	Case Pack: 50pc. 450 lf (137m) Case UPC: 7-51361-50272-5 Case Weight: 20.4 lbs. (9.3kg) Cases per Pallet: 32	Case Pack: 50pc. 500 lf (152m) Case UPC: 7-51361-50162-9 Case Weight: 23 lbs. (10.4kg) Cases per Pallet: 32	Case Pack: 50pc. 600 lf (183m) Case UPC: 7-51361-50274-9 Case Weight: 27.6 lbs. (12.5kg) Cases per Pallet: 32



## Strait-Flex OS-400

DESIGNED FOR OUTSIDE 90° CORNERS WHERE LARGE VOIDS AND IRREGULARITIES OCCUR. DOUBLE 5/8" DRYWALL

4" w (102mm)

- Double 5/8" drywall applications and outside 90° corners where there are large drywall irregularities.
- Diamond-punched paper edging allows for easier feathering, faster drying, and the highest bonding strength. Also guarantees an even lay-down of the paper, providing maximum adhesion with no rippling or blistering.
- Clean installation.
- Composite backing provides a tough, durable corner with no rust.
- Nose resists dents and ensures perfect corners without paper fuzz-up during finishing and sanding.

### SPECIFICATIONS

8 FT STICK (244cm)	9 FT STICK (274cm)	10 FT STICK (305cm)	12 FT STICK (366cm)
Item No. <b>OS400-8</b> Item Size: 4" x 8' (102mm x 244cm)	Item No. <b>OS400-9</b> Item Size: 4" x 9' (102mm x 274cm)	Item No. <b>OS400-10</b> Item Size: 4" x 10' (102mm x 305cm)	Item No. <b>OS400-12</b> Item Size: 4" x 12' (102mm x 366cm)
WHOLESALE CASE	WHOLESALE CASE	WHOLESALE CASE	WHOLESALE CASE
Case Pack: 50pc. 400 lf (122m) Case UPC: 7-51361-50265-7 Case Weight: 23.4 lbs. (10.6kg) Cases per Pallet: 32	Case Pack: 50pc. 450 lf (137m) Case UPC: 7-51361-50268-8 Case Weight: 26.5 lbs. (12kg) Cases per Pallet: 32	Case Pack: 50pc. 500 lf (152m) Case UPC: 7-51361-50270-1 Case Weight: 30 lbs (13.6kg) Cases per Pallet: 32	Case Pack: 50pc. 600 lf (183m) Case UPC: 7-51361-50284-8 Case Weight: 36 lbs. (16.3kg) Cases per Pallet: 32

# Stick Corner Beads

## COMPOSITE

### FEATURES

Impact resistant nose for high-traffic areas where bumps and dents to corners commonly occur.

Installs square to the wall using one of Strait-Flex's specially designed rolling tool.

Beaded nose creates a perfect clean edge.

Second coat of compound can be applied immediately – very light skim coat to finish.

Provides a beautiful corner without fuzz-up during finishing and sanding.

Cuts easily.

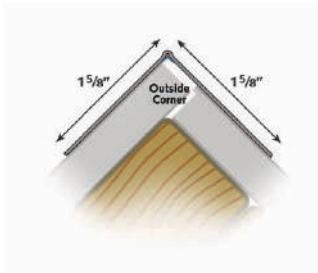
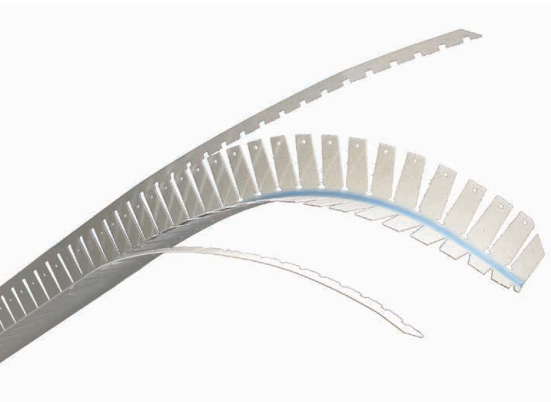
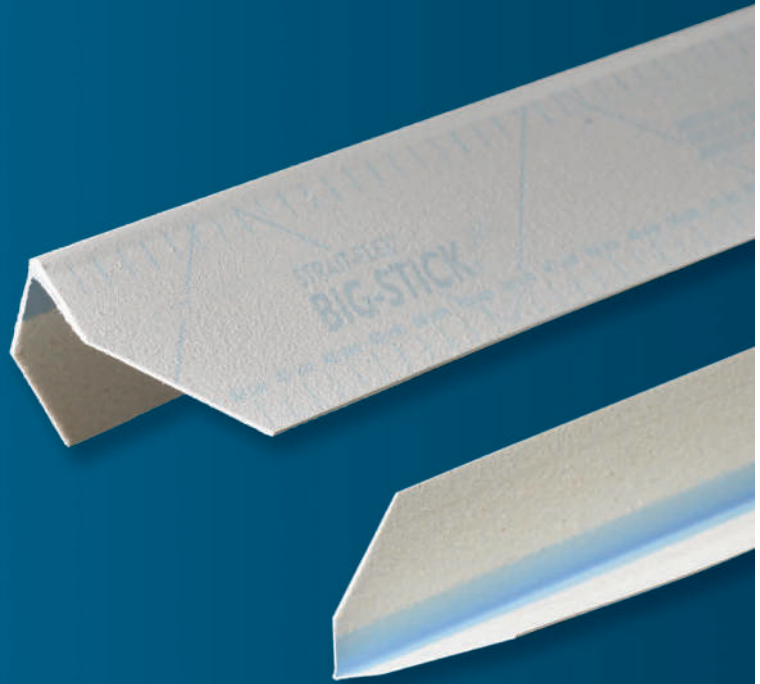

## Strait-Flex Arch-Stick

DESIGNED FOR OUTSIDE 90° ARCHED CORNERS  
ELIMINATING FLAT SPOTS

3 3/8" w (86mm)

- ❑ Tear strips reduces transportation damage and is designed to make curved to straight transitions unnoticeable.
- ❑ Composite nose resists dents and provides a beautiful corner without fuzz-up during finishing and sanding.
- ❑ Arched doors and windows.
- ❑ Curved walls, ceilings, soffits, staircases, and groin barrel ceilings.
- ❑ Free-form, custom drywall applications where a seamless installation is required.

### SPECIFICATIONS

8 FT STICK (244cm)	10 FT STICK (305cm)
Item No. <b>AS-8</b> Item Size: 3 3/8" x 8' (86mm x 244cm)	Item No. <b>AS-10</b> Item Size: 3 3/8" x 10' (86mm x 305cm)
WHOLESALE CASE	WHOLESALE CASE
Case Pack: 25 pc. 200 lf (61m) Case UPC: 7-51361-50168-1 Case Weight: 13 lbs. (9.5kg) Cases per Pallet: 32	Case Pack: 25 pc. 250 lf (76m) Case UPC: 7-51361-50172-8 Case Weight: 17 lbs. (7.7kg) Cases per Pallet: 32





## Strait-Flex Big-Stick

DESIGNED FOR HIGH-TRAFFIC, OUTSIDE 90° CORNERS.  
FAST, CLEAN, STRAIGHT AND STRONG INSTALLATION

3" w (76mm)

- Vertical or horizontal outside 90° corners.
- Impact resistant nose for high traffic areas where bumps and dents to corners most commonly occur.
- Provides a beautiful corner without fuzz-up during finishing and sanding.
- Spans over large gaps without shrinking.
- Easiest corner bead on the market to install.
- Second coat of compound can be applied immediately – very light skim coat to finish.

### SPECIFICATIONS

8 FT STICK (244cm)	9 FT STICK (274cm)	10 FT STICK (305cm)	12 FT STICK (366cm)
Item No. <b>BS300-8</b> Item Size: 3" x 8' (76mm x 244cm)	Item No. <b>BS300-9</b> Item Size: 3" x 9' (76mm x 274cm)	Item No. <b>BS300-10</b> Item Size: 3" x 10' (76mm x 305cm)	Item No. <b>BS300-12</b> Item Size: 3" x 12' (76mm x 366cm)
WHOLESALE CASE	WHOLESALE CASE	WHOLESALE CASE	WHOLESALE CASE
Case Pack: 50pc. 400 lf (122m) Case UPC: 7-51361-50164-3 Case Weight: 24.7 lbs. (11.2kg) Cases per Pallet: 32	Case Pack: 50pc. 450 lf (137m) Case UPC: 7-51361-50181-0 Case Weight: 28 lbs. (12.7kg) Cases per Pallet: 32	Case Pack: 50pc. 500 lf (152m) Case UPC: 7-51361-50166-7 Case Weight: 34 lbs. (15.4kg) Cases per Pallet: 32	Case Pack: 50pc. 600 lf (183m) Case UPC: 7-51361-50183-4 Case Weight: 43 lbs. (19.5kg) Cases per Pallet: 32

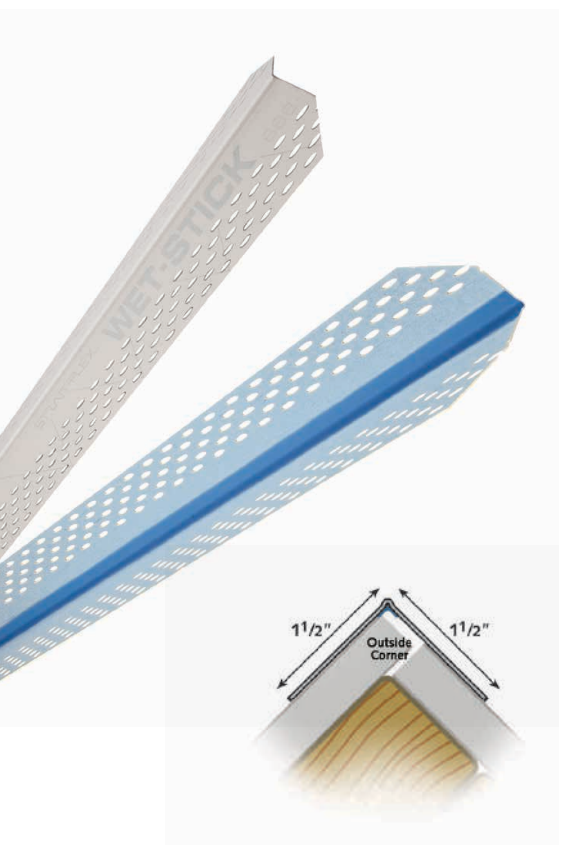

## Strait-Flex Wet-Stick

DESIGNED FOR OUTSIDE 90° CORNERS  
WITHOUT THE NEED OF COMPOUND OR FASTENERS.  
WATER-ACTIVATED ADHESIVE.

3" w (76mm)

- Vertical or horizontal outside 90° corners.
- High traffic areas where bumps and dents commonly occur.
- Water-activated adhesive on inside of stick.
- Impact-resistant nose.
- Small bead creates a perfect, clean edge.
- Small fill coat. Fast drying.
- Provides beautiful corner without fuzz-up during finishing and sanding.
- No delayed shrinkage.
- No edge cracking.

### SPECIFICATIONS

8 FT STICK (244cm)	9 FT STICK (274cm)	10 FT STICK (305cm)	12 FT STICK (366cm)
Item No. <b>WS-8</b> Item Size: 3" x 8' (76mm x 244cm)	Item No. <b>WS-9</b> Item Size: 3" x 9' (76mm x 274cm)	Item No. <b>WS-10</b> Item Size: 3" x 10' (76mm x 305cm)	Item No. <b>WS-12</b> Item Size: 3" x 12' (76mm x 366cm)
WHOLESALE CASE	WHOLESALE CASE	WHOLESALE CASE	WHOLESALE CASE
Case Pack: 50pc. 400 lf (122m) Case UPC: 7-51361-50240-4 Case Weight: 24.7 lbs. (11.2kg) Cases per Pallet: 32	Case Pack: 50pc. 450 lf (137m) Case UPC: 7-51361-50242-8 Case Weight: 28 lbs. (12.7kg) Cases per Pallet: 32	Case Pack: 50pc. 500 lf (152m) Case UPC: 7-51361-50244-2 Case Weight: 34 lbs. (15.4kg) Cases per Pallet: 32	Case Pack: 50pc. 600 lf (183m) Case UPC: 7-51361-50246-6 Case Weight: 43 lbs. (19.5kg) Cases per Pallet: 32

## Strait-Flex Perfect-90°

FINISHES INSIDE 90° AND OFF-ANGLE CORNERS

2 1/16" w (52mm)



- Twice as fast and twice as strong compared to conventional paper or mesh tapes.
- Memory-free hinge produces straight inside corners and perfect angles.
- Paper will not fuzz up during sanding like paper and mesh tapes.
- Reinforced paper backing provides strength and rigidity. Spans small gaps in drywall, no back filling needed.
- Finishing compound is not required over laminated surface. Pre-treated to accept primer or paint.

### SPECIFICATIONS

100 FT ROLLS	WHOLESALE CASE
Item Size: 2 1/16" x 100' (52mm x 30.5m) Item Weight: 1.2 lbs. (.54kg) Item UPC: 7-51361-50322-7	Case Item No. <b>P90-100</b> Case Pack: 12 rolls Case UPC: 7-51361-50323-4 Case Weight: 20 lbs. (9.1kg) Cases per Pallet: 24 Pallet Weight: 510 lbs. (231kg) Pallet Size: 40" x 48" x 44"

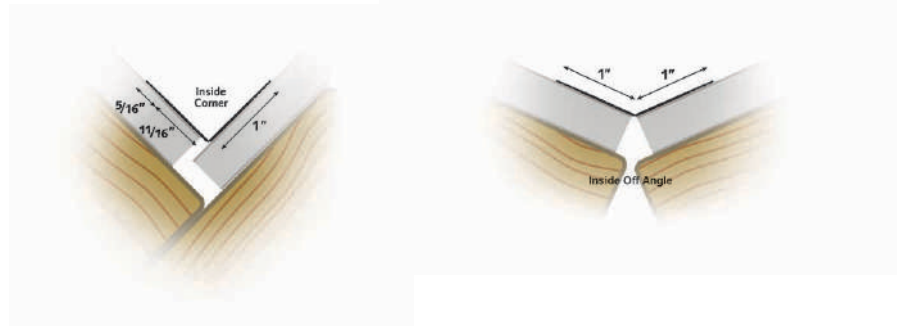

## Strait-Flex Ammo-Flex

DESIGNED FOR BAZOOKA® APPLICATIONS

2 1/16" w (52mm)



- The best flex-tape that runs through a Bazooka®. Cuts easily.
- Inside corners of bay windows.
- Straightens small framing irregularities.
- Prefinished surface. Just skim coat edges to finish.
- Inside 90° corners where small fill or straightening is required.
- NOTE: Reinforced paper backing, not paper-faced composite.

### SPECIFICATIONS

100 FT ROLLS	WHOLESALE CASE	200 FT ROLLS	WHOLESALE CASE
Item Size: 2 1/16" x 100' (52mm x 30.5m) Item Weight: 2.5 lbs. (1.13kg) Item UPC: 7-51361-50324-1	Case Item No. <b>AMF-100</b> Case Pack: 12 rolls Case UPC: 7-51361-50325-8 Case Weight: 26 lbs. (11.8kg) Cases per Pallet: 24 Pallet Weight: 712 lbs. (323kg) Pallet Size: 40" x 48" x 44"	Item Size: 2 1/16" x 200' (52mm x 61m) Item Weight: 4.5 lbs. (2kg) Item UPC: 7-51361-50326-5	Case Item No. <b>AMF-200</b> Case Pack: 12 rolls Case UPC: 7-51361-50327-2 Case Weight: 52 lbs. (23.6kg) Cases per Pallet: 24 Pallet Weight: 1003 lbs. (455kg) Pallet Size: 40" x 48" x 65"

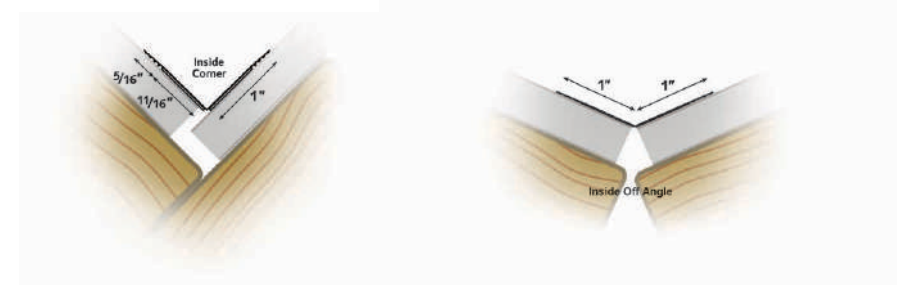



## Strait-Flex Edge-Tape

DESIGNED TO REPLACE TEAR-OFF BEAD

2" w (51mm)

- Designed to finish drywall edges to suspended ceilings.
- Window returns, sky lights, fiberglass tubs. Commercial "Top Out" applications where drywall meets concrete ceiling/deck.
- Twice as fast and uses half the compound vs tear-off beads.
- 100 foot roll reduces waste by up to 20%; easily transported.
- Installs using standard compound. No spray adhesive or fasteners required.
- Finisher can pre-fill edge, install Edge-Tape, and fill coat in one trip to the wall.

### SPECIFICATIONS

100 FT ROLLS	WHOLESALE CASE
Item Size: 2" x 100' (52mm x 30.5m) Item Weight: 2.5 lbs. (1.13kg) Item UPC: 7-51361-50328-9	Case Item No. <b>ET-100</b> Case Pack: 12 rolls Case UPC: 7-51361-50329-6 Case Weight: 34lbs. (11.8kg) Cases per Pallet: 24 Pallet Size: 40"x 48"x 44"

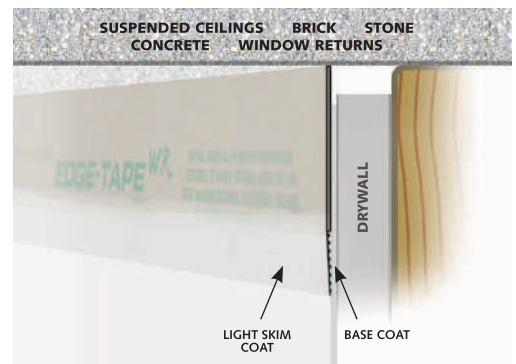

## Strait-Flex L-Bead

DESIGNED TO FINISH EDGES OF DRYWALL

2 1/4" w (57mm)

- L-Bead on a roll that performs like conventional L-Bead.
- Window returns, sky lights, and wall edges.
- Produced for drywall thickness of 1/2" and 5/8. State size when ordering.
- NOTE: Full composite material, not paper-faced.

### SPECIFICATIONS

100 FT ROLLS	WHOLESALE CASE	SIZE CODE
Item Size: 2 1/4" x 100' (57mm x 30.5m) Item Weight: 3 lbs. (1.4kg) <b>LB12-100</b> Item UPC: 7-51361-50332-6 <b>LB58-100</b> Item UPC: 7-51361-50334-0	Case Pack: 12 rolls <b>LB12-100</b> Case UPC: 7-51361-50333-3 <b>LB58-100</b> Case UPC: 7-51361-50335-7 Case Weight: 36 lbs. (16.3kg) Cases per Pallet: 24 Pallet Weight: 894 lbs. (406kg) Pallet Size: 33" x 33" x 49"	<b>LB12-100</b> 1/2" <b>LB58-100</b> 5/8"

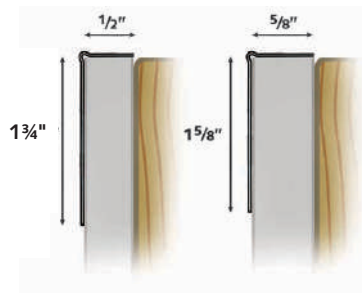

## Strait-Flex Tuff-Tape

DESIGNED FOR STRENGTH AND SPEED AND AS A PAPER TAPE REPLACEMENT

2" w (51mm)



- Inside corners and flat seams.
- Use in areas where humidity causes paper tape to fail and when strength and speed are required.
- Two times stronger than paper tape.
- Resists blisters, tears, and common cracking problems.

### SPECIFICATIONS

#### 100 FT ROLLS

Item Size: 2" x 100'  
(51mm x 30.5m)  
Item Weight: 2.8 lbs. (1.27kg)  
Item UPC: 7-51361-50352-4

#### WHOLESALE CASE

Case Item No. **TT-100**  
Case Pack: 12 rolls  
Case UPC: 7-51361-50353-1  
Case Weight: 36 lbs. (16.3kg)  
Cases per Pallet: 24  
Pallet Weight: 422 lbs. (191kg)  
Pallet Size: 30" x 30" x 46"

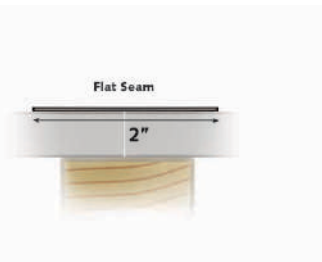
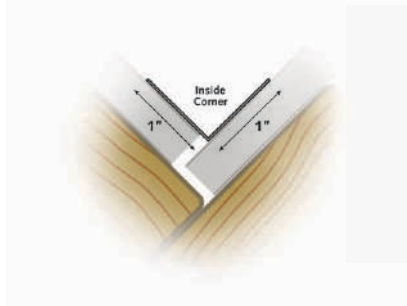

## Strait-Flex Crack-Tape

DESIGNED FOR REPAIRING PERSISTENT CRACKS

2" w (51mm)



- Repairs difficult stress cracks in corners and flat surfaces.
- Drywall and plaster cracks, and truss uplift repairs.
- Persistent cracks.
- Thin coat plaster applications.
- Two times stronger than paper tape.

### SPECIFICATIONS

#### 50 FT ROLLS

Item Size: 2" x 50'  
(51mm x 15.25m)  
Item Weight: 1.1 lbs. (.5kg)  
Item UPC: 7-51361-51462-9

#### WHOLESALE CASE

Case Item No. **CT-50**  
Case Pack: 12 rolls  
Case UPC: 7-51361-51463-6  
Case Weight: 11 lbs. (5kg)  
Cases per Pallet: 24  
Pallet Weight: 342 lbs. (155kg)  
Pallet Size: 33" x 33" x 51"

#### 100 FT ROLLS

Item Size: 2" x 100'  
(51mm x 30.5m)  
Item Weight: 2.1 lbs. (.9kg)  
Item UPC: 7-51361-50356-2

#### WHOLESALE CASE

Case Item No. **CT-100**  
Case Pack: 12 rolls  
Case UPC: 7-51361-50357-9  
Case Weight: 22 lbs. (10kg)  
Cases per Pallet: 24  
Pallet Weight: 606 lbs. (275kg)  
Pallet Size: 33" x 33" x 51"

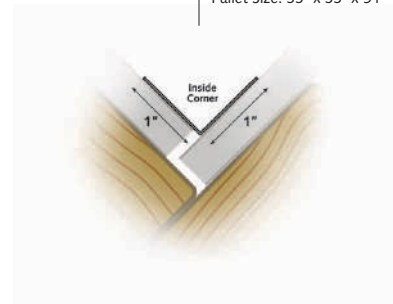
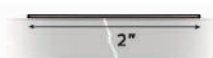



## Strait-Flex Tile-Tape

DESIGNED FOR TILE, MARBLE, AND GRANITE.  
WATER AND MOLD-RESISTANT

2 1/4" w (57mm)



- ❑ Produces straight, strong, and water-proof inside, outside and off-angle corners.
- ❑ Designed for taping the water-resistant backing board for tile and marble applications.
- ❑ Prevents leaks caused by common grout cracks.
- ❑ Twice as strong than paper or mesh tapes.
- ❑ Watertight seams.
- ❑ Mold-resistant. Alkali resistant.
- ❑ Will not cut or snag with notched trowel when applying tile setting compound.
- ❑ Apply over fiber cement board, green board, mold-resistant board, or water-resistant board in wet areas (tubs, showers, tile counter tops, tub deck, and steps).

### SPECIFICATIONS

#### 100 FT ROLLS

Item Size: 2 1/4" x 100'  
(57mm x 30.5m)  
Item Weight: 1.3 lbs. (.59kg)  
Item UPC: 7-51361-50360-9

#### RETAIL CASE

Case Item No. **T-100**  
Case Pack: 6 rolls  
Case UPC: 7-51361-50361-6  
Case Weight: 16 lbs. (7.3kg)  
Cases per Pallet: 24  
Pallet Weight: 414 lbs. (188kg)

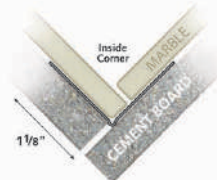
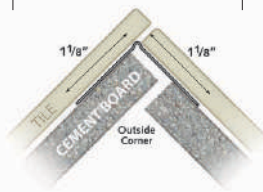

## Strait-Flex Butt-Tape

DESIGNED FOR FAST, FLAT, BUTT-JOINTS

2 1/16" w (52mm)



- ❑ Vertical and horizontal butt-joints.
- ❑ Commercial "Top-Out" applications.
- ❑ Cracked butt joints and stress cracks.
- ❑ Twice as fast as conventional tapes. 50% less compound. 50% less sanding. 50% faster drying time.
- ❑ No pre-filling required. No delayed shrinkage. No beading. No paint blisters.
- ❑ No compound required over laminated area of tape. Just skim coat edges.
- ❑ Apprentices and professional tapers can achieve the flattest butt-joints possible. Leaves butt-joints virtually unnoticeable.
- ❑ Two times stronger than paper or mesh tape.

### SPECIFICATIONS

#### 100 FT ROLLS

Item Size: 2 1/16" x 100'  
(52mm x 30.5m)  
Item Weight: 1.2 lbs. (.54kg)  
Item UPC: 7-51361-50362-3

#### WHOLESALE CASE

Case Item No. **BT-100**  
Case Pack: 12 rolls  
Case UPC: 7-51361-50363-0  
Case Weight: 26.4 lbs. (12kg)  
Cases per Pallet: 24  
Pallet Weight: 664 lbs. (301kg)

#### 200 FT ROLLS

Item Size: 2 1/16" x 200'  
(52mm x 61m)  
Item Weight: 2.4 lbs. (1.1kg)  
Item UPC: 7-51361-50364-7

#### WHOLESALE CASE

Case Item No. **BT-200**  
Case Pack: 12 rolls  
Case UPC: 7-51361-50365-4  
Case Weight: 52 lbs. (23.6kg)  
Cases per Pallet: 24  
Pallet Weight: 1308 lbs. (593.3kg)

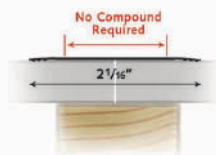

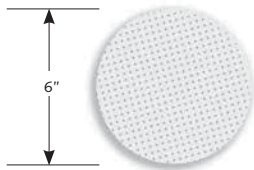

## Ultra-Patch

DRYWALL PATCH

- Outperforms metal patches.
- Quickly repairs damage to drywall.
- The most economical and permanent way to repair drywall.

### SPECIFICATIONS

2-PACK CARD	RETAIL CASE
Item Size: 6" Dia. (15.2cm) Item Weight: .15 lb. (68g) Item UPC: 7-51361-50368-5	Case Item No. <b>ULTP-2PK</b> Case Pack: 50 Cards of 2 Case UPC: 7-51361-50369-2 Case Weight: 8 lbs. (3.6kg) Cases per Pallet: 24
10 COUNT BAG	100 COUNT CASE
Item Size: 6" Dia. (15.2cm) Item Weight: 1.4 lb. (725g) Item UPC: 7-51361-50370-8	Case Item No. <b>ULTP-100</b> Case Pack: 10 bags of 10 Case UPC: 7-51361-50371-5 Case Weight: 14 lbs. (6.4kg)

## Roll-Patches

CONTINUOUS PATCH MATERIAL

- Continuous roll patch allows material to be cut to any length.
- Imprinted with standard electrical outlet patterns to make repairs easy.
- PVC fiber composite material.
- Drywall damage.
- All patching applications.

### SPECIFICATIONS

5.5" WIDTH (14cm) 20 FT ROLLS	WHOLESALE CASE	5.5" WIDTH (14cm) 100 FT ROLLS	WHOLESALE CASE
Item Size: 5 1/2" x 20' (14cm x 6.1m) Item Weight: 1.2 lb. (.55kg) Item UPC: 7-51361-50374-6	Case Item No. <b>RP5.5x20-6</b> Case Pack: 6 rolls Case UPC: 7-51361-50375-3 Case Weight: 7 lbs. (3.2kg) Cases per Pallet: 24 Pallet Weight: 168 lbs. (76kg) Pallet Size: 32" x 32" x 55"	Item Size: 5 1/2" x 100' Item Weight: 5 lb. (2.3kg) Item UPC: 7-51361-50376-0	Case Item No. <b>RP5.5x100-4</b> Case Pack: 4 rolls Case UPC: 7-51361-50377-7 Case Weight: 20 lbs. (9.1kg) Cases per Pallet: 24 Pallet Weight: 504 lbs. (229kg) Pallet Size: 32" x 32" x 55"
11" WIDTH (28cm) 20 FT ROLLS	WHOLESALE CASE	11" WIDTH (28cm) 50 FT ROLLS	WHOLESALE CASE
Item Size: 11" x 20' (30cm x 6.1m) Item Weight: 2.2 lb. (1kg) Item UPC: 7-51361-50378-4	Case Item No. <b>RP11x20-6</b> Case Pack: 6 rolls Case UPC: 7-51361-50379-1 Case Weight: 13.5 lbs. (6.1kg) Cases per Pallet: 24 Pallet Weight: 328 lbs. (149kg) Pallet Size: 33" x 33" x 52"	Item Size: 11" x 50' Item Weight: 5 lb. (2.3kg) Item UPC: 7-51361-50380-7	Case Item No. <b>RP11x50-1</b> Case Pack: 1 roll Case UPC: 7-51361-50381-4 Case Weight: 5 lbs. (2.3kg) Pallet Size: 33" x 33" x 52"

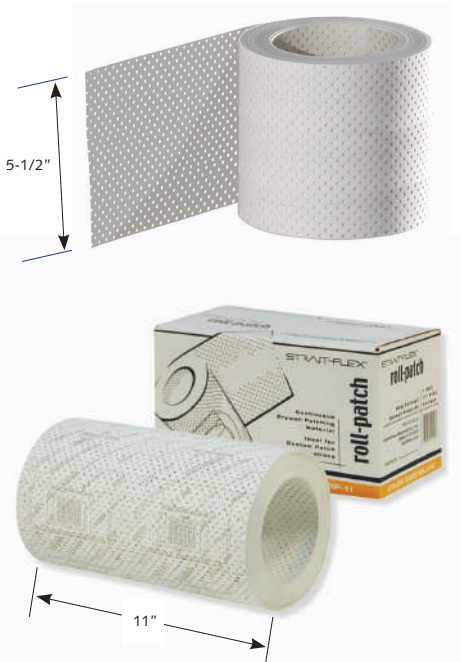

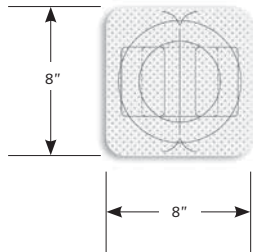

## Perma-Patch

MULTI-PURPOSE DRYWALL PATCH

- Outperforms metal patches.
- Quickly repairs door knob damage to drywall.
- Makes easy repairs to receptacles, ceiling and can lights, and miscuts.
- Imprinted with can light and standard receptacle patterns for easy trimming.
- The most economical and permanent way to repair drywall.

### SPECIFICATIONS

2-PACK CARD	RETAIL CASE	
Item Size: 8" x 8" (20.3cm x 20.3cm) Item Weight: .2 lb. (91g) Item UPC: 7-51361-50382-1	Case Item No. <b>PP-2PK</b> Case Pack: 50 Cards of 2 Case UPC: 7-51361-50383-8 Case Weight: 9.5 lbs. (4.3kg) Cases per Pallet: 24 Pallet Weight: 252 lbs. (114kg) Pallet Size: 30" x 30" x 24"	
10 COUNT BAG	100 COUNT CASE	500 COUNT CASE
Item Size: 8" x 8" (20.3cm x 20.3cm) Item Weight: .5 lb. (226g) Item UPC: 7-51361-50384-5	Case Item No. <b>PP-100</b> Case Pack: 10 bags of 10 Case UPC: 7-51361-50385-2 Case Weight: 6.2 lbs. (2.8kg) Cases per Pallet: 24 Pallet Weight: 173 lbs. (78kg) Pallet Size: 30" x 30" x 24"	Case Item No. <b>PP-500</b> Case Pack: 50 bags of 10 Case UPC: 7-51361-50387-6 Case Weight: 27.3 lbs. (12.4kg) Cases per Pallet: 24 Pallet Weight: 200 lbs. (91kg) Pallet Size: 33" x 33" x 45"

## Outlet-Patch

ELECTRICAL OUTLET PATCH

- Pre-cut to fit standard receptacle boxes.
- Repairs and reinforces mis-cut or damaged areas around receptacle box.
- Very fast, extremely strong.

### SPECIFICATIONS

2-PACK CARD	RETAIL CASE	
Item Size: 4 3/4" x 6 1/4" (12cm x 16cm) Item Weight: .2 lb. (91g) Item UPC: 7-51361-50387-6	Case Item No. <b>OP-2PK</b> Case Pack: 50 Cards of 2 Case UPC: 7-51361-50389-0 Case Weight: 4 lbs. (1.8kg) Cases per Pallet: 24 Pallet Weight: 126 lbs. (57kg)	
10 COUNT BAG	100 COUNT CASE	500 COUNT CASE
Item Size: 4 3/4" x 6 1/4" (12cm x 16cm) Item Weight: .4 lb. (182g) Item UPC: 7-51361-50390-6	Case Item No. <b>OP-100</b> Case Pack: 10 bags of 10 Case UPC: 7-51361-50392-0 Case Weight: 2 lbs. (.9kg) Cases per Pallet: 24 Pallet Weight: 74 lbs. (33.6kg)	Case Item No. <b>OP-500</b> Case Pack: 50 bags of 10 Case UPC: 7-51361-50394-4 Case Weight: 9.2 lbs. (4.2kg) Cases per Pallet: 24 Pallet Weight: 250 lbs. (113kg)

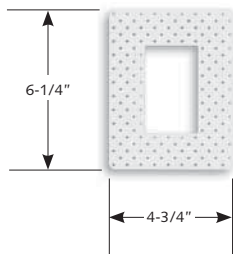





## Head-Patch

SPRINKLER HEAD PATCH, STANDARD AND FLUSH STYLE

- Pre-cut to fit standard sprinkler head safety caps.
- Repairs and reinforces mis-cut or damaged areas around sprinkler head holes.
- Install in areas where patching cutouts were made too large.
- Sprinkler head replacement patch.

### SPECIFICATIONS

<b>10 COUNT BAG</b>	100 COUNT CASE
Item Size: 5" x 2 1/4" Dia. Hole (13cm, 57mm Dia. Hole) Item Weight: .4 lb. (.18kg) Item UPC: 7-51361-50395-1	Case Item No. <b>HP-100</b> Case Pack: 10 bags of 10 Case UPC: 7-51361-50396-8 Case Weight: 1.7 lbs. (.77kg) Cases per Pallet: 24 Pallet Weight: 67 lbs. (30.3kg) Pallet Size: 30" x 30" x 18"



## Black-Iron Patch

SPRINKLER PIPE PATCH

- Pre-cut to fit standard sprinkler pipes.
- Repairs and reinforces mis-cut or damaged areas around sprinkler pipe holes.
- Install in areas where patching cutouts were made too large.
- Sprinkler pipe relocation.

### SPECIFICATIONS

<b>20 COUNT BAG</b>	100 COUNT CASE
Item Size: 4 1/2" x 1 3/8" Dia. Hole (11.4cm, 35mm Dia. Hole) Item Weight: .4 lb. (.18kg) Item UPC: 7-51361-50399-9	Case Item No. <b>BP-100</b> Case Pack: 5 bags of 20 Case UPC: 7-51361-50400-2 Case Weight: 1.5 lbs. (.68kg) Cases per Pallet: 24 Pallet Weight: 60 lbs. (27kg) Pallet Size: 30" x 30" x 18"

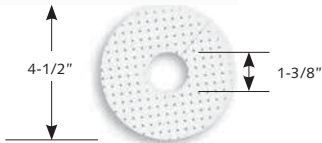

## Pipe-Patch

COPPER PIPE PATCH

- Pre-cut to fit 1/2" and 3/4" copper pipes. (13mm and 19mm)
- Great for fire taping.
- Pipe-Patch repairs and reinforces mis-cut drywall.

### SPECIFICATIONS

<b>1/2" DIA. PATCH (13mm)</b>	100 COUNT CASE	"
Item Pack: 10 patches Item Size: 2 7/8" x 1/2" Dia. Hole (73mm, 13mm Dia. Hole) Item Weight: 1.1 lb. (.5kg) Item UPC: 7-51361-50403-3	Case Item No. <b>PIP50-100</b> Case Pack: 10 bags of 10 Case UPC: 7-51361-50404-0 Case Weight: 4.1 lbs. (1.9kg) Cases per Pallet: 24	
<b>3/4" DIA. PATCH (19mm)</b>	100 COUNT CASE	
Item Pack: 10 patches Item Size: 2 7/8" x 3/4" Dia. Hole (73mm, 19mm Dia. Hole) Item Weight: 1 lb. (.45kg) Item UPC: 7-51361-50406-4	Case Item No. <b>PIP75-100</b> Case Pack: 10 bags of 10 Case UPC: 7-51361-50408-8 Case Weight: 4.1 lbs. (1.9kg) Cases per Pallet: 24	

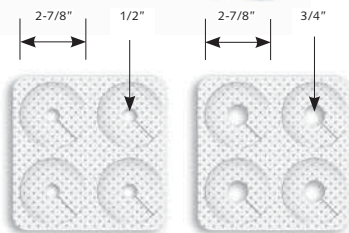

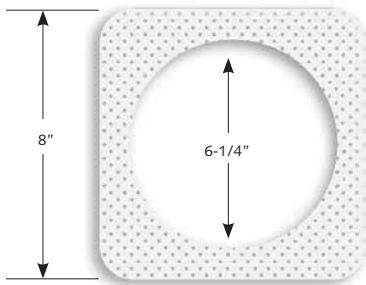

### Can-Patch

CAN LIGHT PATCH (RESIDENTIAL)

- Pre-cut to fit standard residential ceiling lights.
- Repairs and reinforces mis-cut or damaged areas around ceiling lights and can light holes.
- Install in areas where patching cutouts were made too large.
- Ceiling lights and can light relocation.

#### SPECIFICATIONS

10 COUNT BAG	100 COUNT CASE
Item Size: 8" x 8" 6 1/4" Dia. Hole (20.3cm x 20.3cm) 159mm Dia. Hole Item Weight: .4 lb. (.18kg) Item UPC: 7-51361-50411-8	Case Item No. <b>CPR-100</b> Case Pack: 10 bags of 10 Case UPC: 7-51361-50412-5 Case Weight: 3 lbs. (1.36kg)

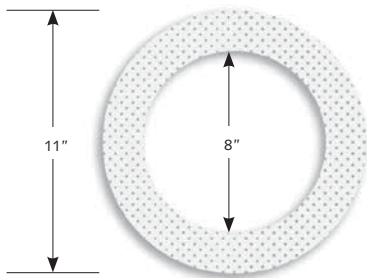

### Can-Patch

CAN LIGHT PATCH (COMMERCIAL)

- Pre-cut to fit standard commercial ceiling lights.
- Repairs and reinforces mis-cut or damaged areas around ceiling lights and can light holes.
- Install in areas where patching cutouts were made too large.
- Ceiling lights and can light relocation.

#### SPECIFICATIONS

10 COUNT BAG	100 COUNT CASE
Item Size: 11" x 8" Dia. Hole (28cm, 20.3cm Dia. Hole) Item Weight: .5 lb. (.23kg) Item UPC: 7-51361-50415-6	Case Item No. <b>CPC-100</b> Case Pack: 10 bags of 10 Case UPC: 7-51361-50416-3 Case Weight: 5 lbs. (2.27kg)

### Deck-Patch

CORRUGATED ROOF DECK PATCH

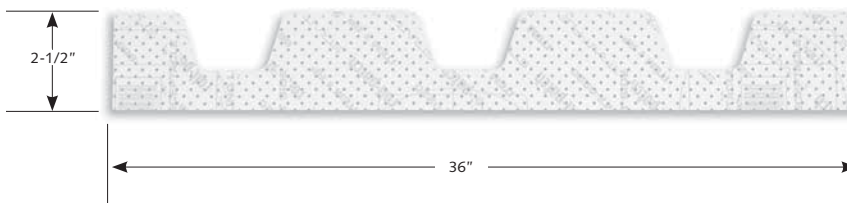

- Custom manufactured to match the contours of different decking.
- Made in three foot sections for easy handling.
- Great as a template for cutting drywall to fit the corrugated decking.
- Perforated PVC fiber composite material.

#### SPECIFICATIONS

Item No. **DP36-34**  
 Item Size: 2 1/2" x 36"  
 (63mm x 91cm)  
 Case Pack: 34 Patches, 102 LF  
 Case UPC: 7-51361-50420-0  
 Cases per Pallet: 24  
 Pallet Weight: 72 lbs. (32.7kg)  
 Pallet Size: 30" x 30" x 10"

State corrugated roof deck manufacturer when ordering.

# Mud-Pro<sup>2</sup>

## FEATURES

The fastest, cleanest, and most durable compound applicator on the market.

Designed to apply precise amounts of compound to inside and outside 90° corner beads, flex tapes, and outside bullnose and chamfer corner beads.

Mix and store compound in same bucket.

Five gallon compound capacity.

No daily clean-up. Just fold legs; drop into 6" of water.

Stainless steel construction for long-life.

Includes Mud-Pro<sup>2</sup> mounted to bucket, and second bucket.



## Mud-Pro 2

COMPOUND APPLICATOR

### SPECIFICATIONS

Item No. **MP2**  
 Case Pack: 1  
 Item Weight: 14 lb. (6.35kg)  
 Item UPC: 7-51361-50421-7

Contact Customer Service with service questions or parts.





**INSIDE ROLLING TOOL**

DESIGNED FOR:  
Original  
Medium  
Uno-Bead<sup>222</sup>  
IS-300  
Gold  
Mid-Flex  
Perfect-90°



**Inside Rolling Tools**

- Speeds application time.
- Squares up corner beads on walls.
- For use with all inside corner products (excl. Wide-Flex)
- Attaches to common extension poles.

**SPECIFICATIONS**

**INSIDE ROLLING TOOL**

Item No. **ISR**  
Item Size: 8" x 17/8" x 17/8"  
Case Pack: 1  
Case Weight: 1.2 lb.  
Item UPC: 7-51361-50423-1

**ORIGINAL ROLLING TOOL**

DESIGNED FOR:  
Original  
Medium  
Uno-Bead<sup>222</sup>

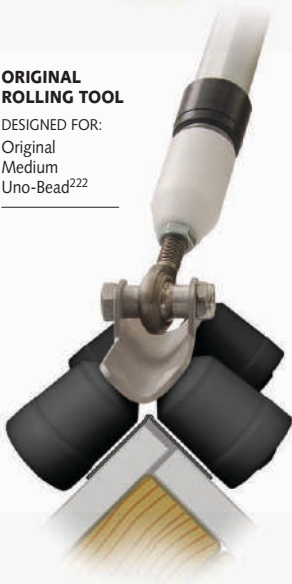

**Outside Rolling Tools**

- Speeds application time.
- Squares up corner beads on walls.
- For use with all outside corner products.
- Attaches to common extension poles.

**SPECIFICATIONS**

ORIGINAL OUTSIDE TOOL	BSR-300 TOOL	OSR-300 TOOL
Item No. <b>OSR</b> Case Pack: 1 Case Weight: 1.2 lb. Item UPC: 7-51361-50425-5	Item No. <b>BSR300</b> Case Pack: 1 Case Weight: 1.2 lb. Item UPC: 7-51361-50427-9	Item No. <b>OSR300</b> Case Pack: 1 Case Weight: 1.2 lb. Item UPC: 7-51361-50429-3
OSR-400 TOOL	WET-STICK TOOL	
Item No. <b>OSR400</b> Case Pack: 1 Case Weight: 1.2 lb. Item UPC: 7-51361-50431-6	Item No. <b>WSR</b> Case Pack: 1 Case Weight: 1.2 lb. Item UPC: 7-51361-50433-0	

**BSR-300 ROLLING TOOL**

DESIGNED FOR:  
Big-Stick  
Arch-Flex  
Arch-Stick

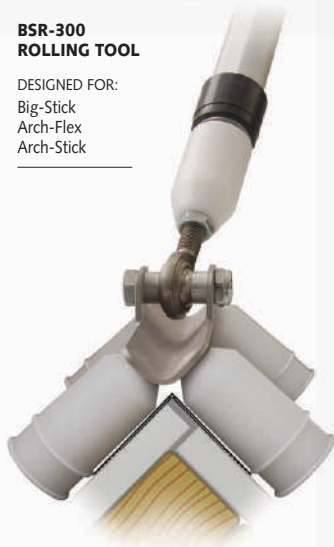

**OSR-300 ROLLING TOOL**

DESIGNED FOR:  
Gold  
Mid-Flex  
OS-300



**OSR-400 ROLLING TOOL**

DESIGNED FOR:  
Wide-Flex  
OS-400



**WET-STICK ROLLING TOOL**

DESIGNED FOR:  
Wet-Stick  
Wet-Flex





## Super-Bond

DRYWALL COMPOUND ADDITIVE

- Ensures maximum bonding of tapes to painted surfaces, drywall, and plaster.
- Excellent additive to all-purpose compound when applying compound over painted surfaces.
- Add one bottle Super-Bond (16 oz.) to five gallon bucket of drywall compound. For individual taping pans, add one oz. Super-Bond per 12" taping pan.
- Compatible with all drywall compounds.

### SPECIFICATIONS

SUPER-BOND	RETAIL CASE
Item Size: 16 fl oz. (.47l) Item UPC: 7-51361-50435-4	Case Item No. <b>SB-12</b> Case Pack: 12 Case UPC: 7-51361-50436-1 Case Weight: 16 lbs. (7.3kg)



## Drywall Shims

- Floating butt-joints and framing irregularities.
- Uses include door jambs, hanging cabinets, countertops, windows, and pre-fabricated shower stall inserts.
- Easy dispensing carton.
- Shims save time by shimming drywall to allow greater inset at joints.
- Shims improves quality as it assists in providing a level surface for better fits.

### SPECIFICATIONS

**45" LENGTH SHIMS** (114cm)

Item No. **DS-100**  
Item Size: 1 1/2" x 45" x 1/16"  
(38mm x 114cm x 1.5mm)  
Case Pack: 100  
Case UPC: 7-51361-50438-5  
Case Weight: 8.6 lbs. (3.9kg)  
Cases per Pallet: 140



## Multi-Purpose Sprayer

DESIGNED FOR EVEN SATURATION OF WET-STICK AND WET-FLEX

- Easy spray, pump activated bottle, adjustable nozzle, thumb trigger.
- 48 fl. oz capacity.

### SPECIFICATIONS

SPRAYER	RETAIL CASE
Item Size: 48 fl oz" (20cm) Item Weight: .8 lbs. (.36kg) Item UPC: 7-51361-50439-2	Case Item No. <b>MPS-6</b> Case Pack: 6 Case UPC: 7-51361-50440-8 Case Weight: 5.5 lbs. (2.5kg)

## Extension Pole

FIBERGLASS AND ALUMINUM POLE



- Telescopic extension pole for painters, drywall contractors, and moving companies.
- Five locking adjustment sizes.
- Comfort grip.
- Adjusts sizes from 3' (91cm) to 5' (152cm) at 6" (15cm) intervals.

### SPECIFICATIONS

Item No. **EP**  
 Item Weight: 1.5 lb. (.68kg)  
 Item UPC: 7-51361-50442-2

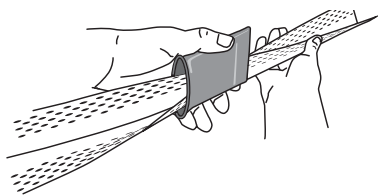

## Flex-Folder

HAND-HELD TAPE FOLDER

- Speeds the folding of all Strait-Flex flexible composite corner beads to correct installation angles.
- Weakens inside hinge to help make angle adjustments.

### SPECIFICATIONS

FLEX-FOLDER	RETAIL CASE
Item Size: 37/16" x 33/8" x 3/8" (87mm x 86mm x 10mm) Item Weight: 1.1 lb. (.5kg) Item UPC: 7-51361-50443-9	Case Item No. <b>FF-12</b> Case Pack: 12 Case UPC: 7-51361-50444-6 Case Weight: 5.25 lbs. (2.4kg)

## Scissors

DESIGNED TO CUT TIME AND TAPE

- Heavy-duty, stainless steel, softgrip scissors, bent design.
- Cuts tapes and composite corner beads easily.



### SPECIFICATIONS

SCISSORS	RETAIL CASE
Item Size: 8" (20cm) Item Weight: .3 lbs. (.14kg) Item UPC: 7-51361-50312-8	Case Item No. <b>SK-12</b> Case Pack: 12 Case UPC: 7-51361-50313-5 Case Weight: 4.25 lbs. (1.93kg)



## X-Crack

### FEATURES

#### Flexible Tabs

Allow structural movement independent from the drywall inside corner joint.

Straightens uneven roof framing members during installation.

Pre-drilled for easy installation.

#### PVC Hinge

Adjusts to all inside and outside angles.

For inside corners, the surface of the PVC hinge faces the framing members.

For outside corners, the surface of the PVC hinge faces out.



**NO CRACKS** X-Crack® eliminates all cracks in vaulted ceilings, butterfly vaults, and inside 90-degree corners in flat ceiling areas caused by truss uplifts. This patented product holds drywall joints stationary while allowing structural movement of framing members.

**STRAIGHTENS** X-Crack's rigid design, hinged backbone, and flexible tab design will straighten all uneven framing members. This pre-straightening of sub-structure will eliminate the need of all pre-filling due to irregularities of framing members. It makes easy work of intricate ceiling applications that have no backing.

**FAST** X-Crack is adjustable to any inside or outside angle and installs in minutes. X-Crack will reduce finishing time by the elimination of pre-filling and pre-straightening. Your drywall finisher will start with a perfectly even and straight joint.

**PERMANENT** Follow the installation instructions and you will solve the age-old problem of ceiling cracks and uneven framing!

**DESCRIPTION** X-Crack is a patented, floating alignment joint member manufactured from 24 mil G90 galvanized steel and is available at your local drywall distributor in ten feet length rolls. Each X-Crack carton contains ten 10' rolls (100 lineal ft).



ADVANTAGES

Eliminates inside and outside cracks in ceiling corner joints.

Eliminates costly repairs due to ceiling cracks and the inconvenience to dissatisfied home owners.

Eliminates pre-filling or pre-straightening by finisher when ceiling members are not in alignment.

Quick installation time - 50 feet of X-Crack takes about 10 minutes to install.

Perfectly straight inside and outside ceiling corners.

Makes easy work of complex, intricate ceiling applications that have no backing or uneven framing.

Eliminates wood backing in vaulted areas.

Provides straight continuous backing for fastening in tee-pee ceilings and butterfly vaults.

The time saved by the drywall finisher pays for the material costs many times over.

Combined use of X-Crack and Strait-Flex Gold or Mid-Flex flexible corner trim results in permanent protection against cracks.

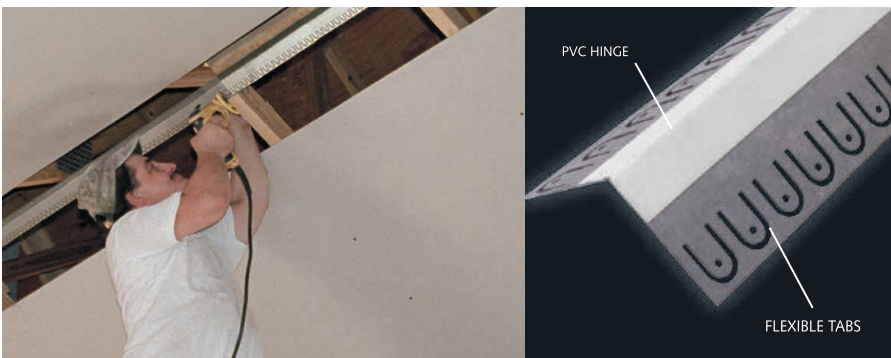

## Strait-Flex X-Crack

### FRAMING ALIGNMENT

- Eliminates ceiling cracks and straightens uneven framing.
- Drywall ceiling areas that use wood roof trusses or conventional wood framing members.
- Intricate ceiling applications, such as tee-pee ceilings in octagon rooms and butterfly vaults.
- Areas where framing members are out of alignment.
- Ceiling areas where drywall is not properly supported.
- Ceiling areas where movement may occur.
- Stainless steel construction for long-life.

### SPECIFICATIONS

Item No. **X-R**  
 Item Size: 4 1/4" x 10'  
 (10.8cm x 305cm)  
 Case Pack: 10 pc. 10 ft long, 100 lf (30.5m)  
 Case UPC: 7-51361-50367-8  
 Case Weight: 21 lbs. (9.5kg)  
 Cases per Pallet: 24 or 48  
 Pallet Weight: 544 lbs. 1048 lbs.  
 (247kg, 475kg)

### Installation Requirements to Eliminate Potential For Cracks

Adjust X-Crack to desired angle and use drywall screws to fasten it to ceiling framing members. Install drywall over X-Crack using fine or coarse threaded screws – be sure screws only penetrate drywall and X-Crack but miss trusses or ceiling joists by 2 to 4 inches. You must install the last screws in the field 10 to 12 inches away from X-Crack to allow for lumber movement. By missing the framing members and fastening drywall boards only to X-Crack; finished inside corners will not move or crack. Use Strait-Flex **Gold** or **Mid-Flex** flexible corner trim to complete installation.

**NO SCREW SHOULD PENETRATE ALL THREE MATERIALS**  
 (drywall - X-Crack - framing members)



U.S. Patent No. 9,222,266



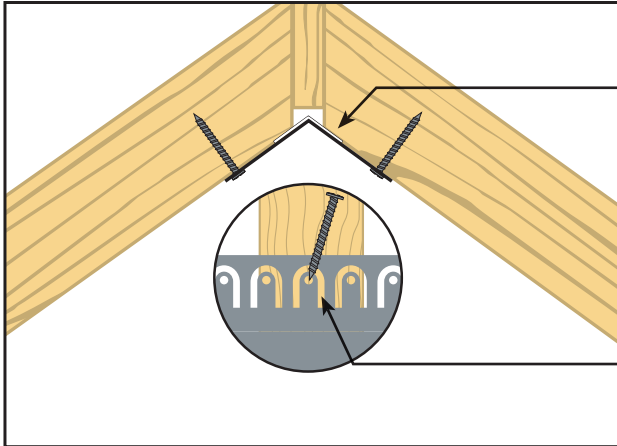

**Installation Instructions**

Fasten X-Crack to ceiling trusses or conventional framing members before drywall installation.

**Directions for Use**

- 1 Adjust X-Crack to angle of corner. For inside corners, surface of PVC hinge faces framing members. For outside corners, surface of PVC hinge faces out.
- 2 Using drywall screws, first fasten X-Crack at end of lengths. Align center and fasten to framing members. Overlap X-Crack approximately one inch at joints.
- 3 Let X-Crack float over irregular framing members to create a straight line. Six screws per length is all that is required to hold X-Crack in place. The last screws in the field secures drywall to ceiling - and the screws through drywall into body of X-Crack secures inside corners.

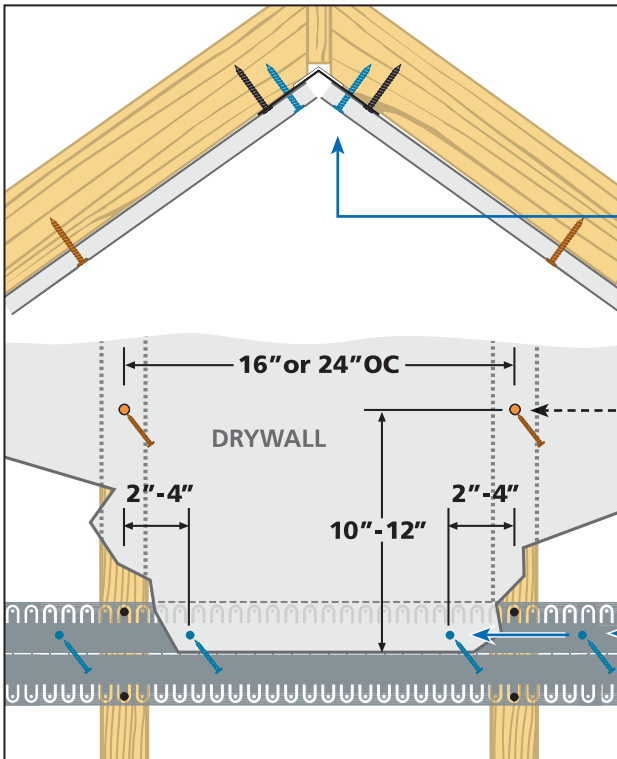

- 4 Install drywall over X-Crack with fine or coarse drywall screws. Be sure the drywall screws penetrate the X-Crack product but miss the truss or ceiling joist by 2 to 4 inches. The last screw in the field should be 10 to 12 inches away from X-Crack. This allows ceiling members to move independently of drywall joint.
- 5 Use Strait-Flex **Gold** or **Mid-Flex** flexible corner bead to finish the application.

 SCREWS THAT SECURE X-CRACK TO CEILING MEMBER  
Penetrates: X-Crack, Framing Member

 SCREWS THAT SECURE DRYWALL TO X-CRACK  
Penetrates: Drywall, X-Crack

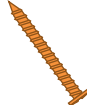
 LAST SCREWS IN FIELD  
Penetrates: Drywall, Framing Member

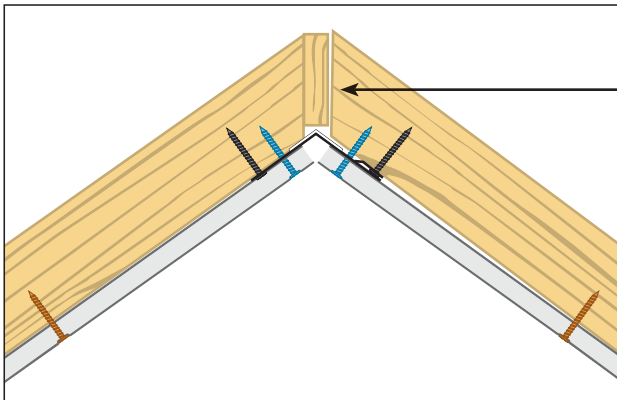

X-Crack's patented hinge and flexible tab design holds drywall joints stationary while structural framing members are allowed to move independently of the drywall. Causes for this movement may be due to lumber shrinkage, snow or wind loads, and truss uplift.

Please call ClarkDietrich  
with any product  
questions or concerns.  
1-888-747-0220

### DO'S

Keep a bucket of water nearby for mixing and tool clean up.

Use all-purpose compound for bed coat and coating screws.

Add water and mix compound thoroughly to a smooth creamy texture.

Keep the inner side walls of the compound bucket clean and smooth with a wet sponge. Hardened compound on the sides of the bucket could fall into the smooth compound and will streak when applied to the drywall surface.

Set all screws below the surface of the drywall. Check with a taping knife as the knife will snag on screws not set deep enough.

Use a brush to wipe away any dust before applying compound.

For outside corners, use a drywall rasp to remove any drywall edges that extend over the adjacent drywall surface.

Use the correct product for the job. The better the framing and hanging; the smaller the product. The larger the gaps, the worse the framing; the larger the product.

(Composite flexible corner beads) Always fold print side together. Fold tighter for outside corners and more open for inside corners. This ensures the product lays flat on the wall.

(Paper-faced flexible corner trims) Print side faces out for both inside and outside corners.

Trim the ends of corner beads and trims at a 45° angle. This will keep them flat on wall.

(Patches) Apply compound to the back of all patches, flip over, and apply patch to the damaged area. Strait-Flex patches become rigid because of compound on back of patch.

Use 150-200 grit sandpaper when finish coat is lightweight compound (softer compound). Use 100-150 grit sandpaper when finish coat is all-purpose compound (harder compound).

### DONT'S

Use light-weight finishing compound for bed coats. Light-weight compounds don't have the strength of taping compounds.

Dilute compound with too much water.

Use the wrong size product for the job.

Overlap tapes or corner beads.

**THE RIGHT PRODUCT FOR THE RIGHT APPLICATION**

rolled products			Product Total Width	Gaps Filled in Drywall	Outside 90° Corners	Inside 90° Corners	Off-Angle Corners	Vaults	Seams	Butt-Joints	Cracks	Wet Areas	Curves, 90° Corners	Free-Form Curves	Veneer Plaster	Double 5/8" 90° Corners	Repairs Metal Corner Bead	High Traffic Areas	Mold-Resistant	Full Composite	Paper-Faced Composite	Paper-Faced Cellulose Laminate
<b>Tuff-Tape</b>	Use where paper tapes has failed	2"	Small	✓				✓											✓			
<b>Crack-Tape</b>	Persistent cracks	2"	Reg	✓				✓		✓			✓						✓			
<b>Edge-Tape</b>	Finishes edges of drywall	2"	Reg																	✓		
<b>Perfect-90°</b>	Faster and stronger than paper tape	2 1/16"	Small	✓	✓																✓	
<b>Ammo-Flex</b>	Bazooka® applications	2 1/16"	Small	✓	✓																✓	
<b>Butt-Tape</b>	Fast, flat butt-joints	2 1/16"	Small					✓	✓												✓	
<b>Medium</b>	Inside corners and off-angle corners	2 1/4"	Small	✓	✓															✓		
<b>Tile-Tape</b>	Wet areas, Mold-proof	2 1/4"	Reg	✓	✓	✓		✓			✓							✓	✓	✓		
<b>Uno-Bead 222</b>	Drywall, plaster	2 1/4"	Reg	✓	✓	✓							✓		✓	✓			✓	✓		
<b>L-Bead</b>	Finishes edges of drywall	2 1/4"	Reg																	✓		
<b>Original</b>	Most versatile, multi-purpose	2 3/8"	Reg	✓	✓	✓														✓		
<b>Gold</b>	Inside & outside 90° and off-angle corners	2 1/2"	Reg	✓	✓	✓	✓														✓	
<b>Mid-Flex</b>	Inside & outside 90° and off-angle corners	3"	Reg	✓	✓	✓	✓														✓	
<b>Wet-Flex</b>	Outside corners, vaults, water activated	3"	Large	✓		✓															✓	
<b>Arch-Flex</b>	Compound arches, double curves applications	3 3/8"	Reg								✓	✓									✓	
<b>Wide-Flex</b>	Inside & outside 90° and off-angle corners	4"	Large	✓	✓	✓	✓							✓							✓	

stick products			Product Total Width	Gaps Filled in Drywall	Outside 90° Corners	Inside 90° Corners	Off-Angle Corners	Vaults	Seams	Butt-Joints	Cracks	Wet Areas	Curves, 90° Corners	Free-Form Curves	Veneer Plaster	Double 5/8" 90° Corners	Repairs Metal Corner Bead	High Traffic Areas	Mold-Resistant	Full Composite	Paper-Faced Composite	Paper-Faced Cellulose Laminate
<b>IS-300</b>	Inside 90°, straightens large irregularities	3"	Large	✓																	✓	
<b>Big-Stick</b>	Outside 90°, straightens common irregularities	3"	Reg	✓												✓					✓	
<b>Wet-Stick</b>	Outside 90°, water-activated	3"	Reg	✓												✓					✓	
<b>OS-300</b>	Outside 90°, straightens common irregularities	3"	Reg	✓																	✓	
<b>Arch-Stick</b>	Outside 90° arched corners	3 3/8"	Reg	✓							✓	✓									✓	
<b>OS-400</b>	Outside 90°, straightens large irregularities	4"	Large	✓										✓							✓	





ClarkDietrich®

3851 Corporate Centre Drive  
O'Fallon, MO 63368

Phone: 636-300-1411

Fax: 636-300-0414

For more information,  
call toll-free 1-888-747-0220  
or visit [www.clarkdietrich.com](http://www.clarkdietrich.com)

SF-PROD-CAT © 11/22 CLARKWESTERN DIETRICH BUILDING SYSTEMS, LLC